

SS436 & SHS436 Filter Housing

Materials 316L Stainless Steel
Pressure 3000 psi
Ports 1" to 2"
Element 51.476.□

SS436 series filter housings are specified for 1" line size applications up to 3000 psi. The SHS436 series are for 1&1/2" and 2" applications and are designed to have a full bore flow path to give higher flow rates. For applications over 3000 psi high pressure versions are available, see the SS438 filter housings.

Standard housings have NPT ports and Viton seals. Other seal types are available as an option. BSPT and BSPP port types are also available.

The housings are free from welds and comply with NACE MR-01-75 and are CE marked in accordance with PED 97/23/EC.

These housings can also be supplied in a wide range of exotic materials, such as Hastelloy, Monel, Titanium etc.

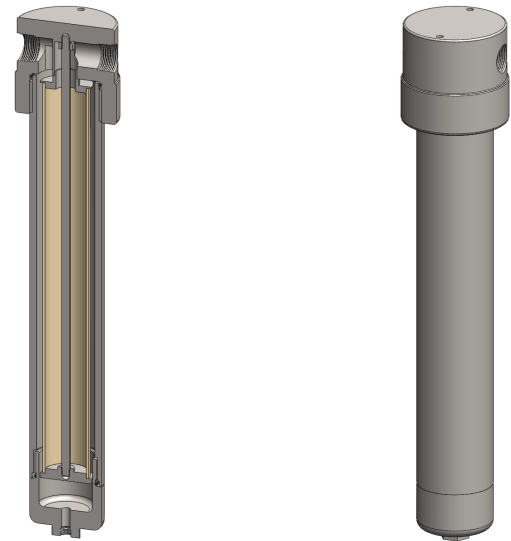

Technical Specifications

Housing Model	SS436.621	SS436.641	SHS436.721	SHS436.741	SHS436.821	SHS436.841
Port Size	1" NPT	1" NPT	1&1/2" NPT	1&1/2" NPT	2" NPT	2" NPT
Drain	1/4" NPT	1/2" NPT	1/4" NPT	1/2" NPT	1/4" NPT	1/2" NPT
Maximum Pressure, psi (1)	3000	3000	3000	3000	3000	3000
Maximum Temperature, °F (2)	390	390	390	390	390	390
Materials of Construction (3)						
Head, Bowl & Internals	316L SS	316L SS	316L SS	316L SS	316L SS	316L SS
Seal (4)	Viton	Viton	Viton	Viton	Viton	Viton
Filter Element Code (5)	51.476.□	51.476.□	51.476.□	51.476.□	51.476.□	51.476.□
Adsorber Cartridge Code (6)	51.476.AD□	51.476.AD□	51.476.AD□	51.476.AD□	51.476.AD□	51.476.AD□
Principle Dimensions in inches						
Diameter	4.70	4.70	7.10	7.10	7.10	7.10
Height	24.60	24.60	26.15	26.15	26.55	26.55
Volume, cc	2500	2500	2550	2550	2550	2550
Weight, lbs	41.60	41.60	92.40	92.40	99.00	99.00
Accessories						
Support Core	SCSS43	SCSS43	SCSS43	SCSS43	SCSS43	SCSS43
Mounting Bracket	MBSS42	MBSS42	MBSHS42	MBSHS42	MBSHS42	MBSHS42

Notes

- (1) Above 390°F the pressure rating is reduced, consult us for the exact rating at any specific temperature
- (2) Maximum temperature 390°F using standard seal. For temperatures up to 615°F use a Chemraz seal
- (3) Material abbreviations, 316L SS = 316L Stainless Steel
- (4) Add suffix for other seal types, Chemraz = .C, Nitrile = .N, Kalrez = .K, EPDM = .E, Silicone = .S, (e.g. SS436.621.N)
- (5) Replace the □ with the grade required, e.g. 51.476.5CK, 51.476.S20V, 51.476.T20
- (6) Replace the □ with the type required, e.g. 51.476.AD01