

Materials 316L Stainless Steel
Pressure 1500 psi
Ports 1/4" or 1/2"
Element 25.64.□
Membrane MT.61.□

SM215 combination housings have a coalescing filter element and a PTFE membrane in a single unit.

The porous PTFE membrane is supported by a sintered porous stainless steel disc on the outlet side. The wet sample gas enters the inlet port and then through the coalescing element to remove the bulk of the liquid and solid particles and then to the membrane. Any liquid in the gas sample will flow to the drain port. This port can also be used as a bypass function for the main flow.

Standard housings have NPT ports and include Viton seals. Other seal types are available as an option. BSPT and BSPP port types are also available.

The housings are free from welds and comply with NACE MR-01-75.

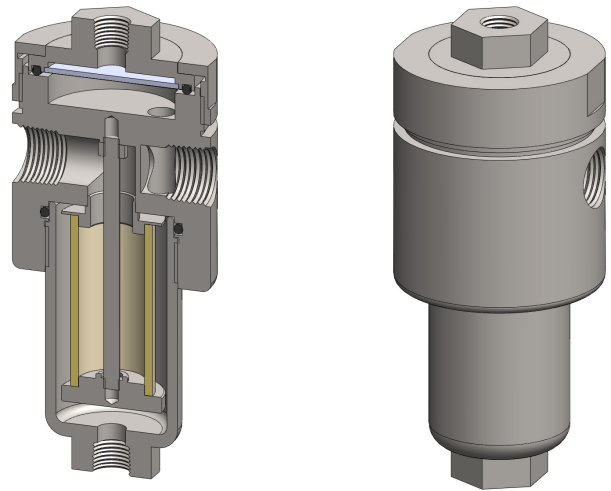

Technical Specifications

Housing Model	SM215.221	SM215.421
Port Size	1/4" NPT	1/2" NPT
Drain & Bypass Ports	1/4" NPT	1/4" NPT
Maximum Pressure, psi	1500	1500
Maximum Temperature, °F (1)	300	300
Materials of Construction (2)		
Head, Bowl & Internals	316L SS	316L SS
Seals (3)	Viton	Viton
Filter Element Code (4)	25.64.□	25.64.□
Membrane Code (5)	MT.61.□	MT.61.□
Principle Dimensions in inches		
Diameter	2.95	2.95
Height	6.65	6.65
Volume, cc	135	135
Weight, lbs	6.15	6.15
Accessories		
Mounting Bracket	MBSM215	MBSM215

Notes

- (1) Maximum temperature of 300°F is due to the PTFE membrane
- (2) Material abbreviations, 316L SS = 316L Stainless Steel
- (3) Add suffix for other seal types, PTFE = .T, Chemraz = .C, Nitrile = N, Kalrez = .K, EPDM = .E, Silicone = .S, (e.g. SM215.221.T)
- (4) Replace the □ with the element grade required, e.g. 25.64.5CK
- (5) Replace the □ with the membrane grade required, e.g. MT.61.M2